

Bimetallic Overload Relay Specifications

Bulletin Number 193-K, 193-T1

Topic	Page
Product Overview	2
Standards compliance and Certifications	2
General Specifications—193-K	3
Approximate Dimensions—193-K	5
General Specifications—193-T1	6
Approximate Dimensions—193-T1	11

Additional Resources

These documents contain additional information concerning related products from Rockwell Automation.

Resource	Description
Industrial Automation Wiring and Grounding Guidelines, publication 1770-4.1	Provides general guidelines for installing a Rockwell Automation industrial system.
Product Certifications website, http://www.ab.com	Provides declarations of conformity, certificates, and other certification details.

You can view or download publications at <http://www.rockwellautomation.com/literature/>. To order paper copies of technical documentation, contact your local Allen-Bradley distributor or Rockwell Automation sales representative.



Bulletin	193-K	193-T1
Type	Bimetallic Overload Relay	
Rated Current (Range)	0.1...12.5 A	0.1...90 A
Operating Voltage, Nominal	600V	
Overload Type	Bimetallic	
Trip Class (Fixed)	10	10
Ambient Temperature Compensated	✓	✓
Reset Type	Automatic and Manual	Automatic and Manual
Adjustment Range	1.5:1	1.5:1
Phase Loss	Normal Sensing	Normal Sensing
N.C. Trip Contact	✓	✓
N.O. Alarm Contact	✓	✓
Variable Frequency Drive (VFD) Compatible	✓	✓

Standards Compliance—193-K

IEC/EN 60947-1,-4-1,-5-1
 UL 508
 CSA 22.2. No. 14

Certifications—193-K

CE Marked
 cULus Listed (File No. E33916, Guide NKCR, NKCR7)

Standards Compliance—193-T1



IEC/EN 60947-1, -4-1, -5-1
 UL508
 CSA C22.2 No.14

Certifications—193-T1



cULus (File No. E33916, Guide NKCR, NKCR7),
 CE marked

Specifications

Main Circuits

		193-K
Rated Isolation Voltage U_i		690V
Rated Impulse Strength U_{imp}		6 kV
Rated Operating Voltage U_e IEC/UL		690V AC / 600V AC
Wiring cross section Terminal type		
Terminal screws		M3.5
 Fine stranded with ferrule [mm ²]		2 x (1.5...4)
 Solid or coarse stranded [mm ²] [AWG]		2 x (1.5...4) 2 x (16...12)
Recommended torque [N•m] [lb•in]		1.2 10.6
Pozidriv screwdriver	Size	2
Slotted screwdriver	[mm]	1 x 6

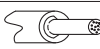
Control Circuits

		193-K
Rated Isolation Voltage U_i		690V AC
Rated Impulse Strength U_{imp}		4 kV AC
Rated Operating Voltage U_e IEC/UL		690V AC/600V AC
Rating Designation		A600/Q300
Rated Operating Current I_e		N.O./N.C.
AC-15	24V [A]	4
	240V [A]	2
	400V [A]	1.6
	690V [A]	0.15
DC-13	24V [A]	2
	110V [A]	0.4
	220V [A]	0.25
	440V [A]	0.08
Thermal Current I_{the} [A]		5
Short-circuit withstand, fuse gG [A]		6
Contact Reliability		15V, 2 mA
Wiring cross section Terminal type		
Terminal screw		M 3.5
 Fine stranded with ferrule [mm ²]		2 x (1...4)
 Solid or coarse stranded [mm ²] [AWG]		2 x (1...4) 2 x (18...12)
Recommended torque [N•m] [lb•in]		1.2 10.6
Pozidriv screwdriver	Size	2
Slotted screwdriver	[mm]	1 x 6

Environmental Ratings

		193-K
Ambient Temperature	Storage Operating	-55...+80 °C (-67...+176 °F) -20...+60 °C (-4...+140 °F)
Humidity	Operating Damp Heat	5...95% Non-condensing per IEC/EN 60068-2-3 and IEC/EN 60068-2-30
Vibration (per IEC/EN 60068-2-6)		3 G
Shock (per IEC/EN 60068-2-27)		30 G
Max. Altitude		2000 m
Pollution Environment		Pollution Degree 3
Degree of Protection		IP2X
Protection		
Type of Relay		Ambient compensated, time delay, phase loss sensitive
Nature of Relay		Bimetallic overload relay
Trip Rating		120% FLA
Trip Class		IEC: 10A, UL 10
Reset Mode		Automatic or manual
Power dissipation	up to 0.4 A	7 W
	0.5...12.5 A	6 W

General Data

		193-K
Standards		IEC/EN 60947-1, -4-1, -5-1, UL 508, CSA 22.2. No. 14
Certifications		CE, cULus
Approximate Weights (unpackaged)		0.115 kg (0.25 lb)

Thermal Overload Relays

Circuit Diagrams

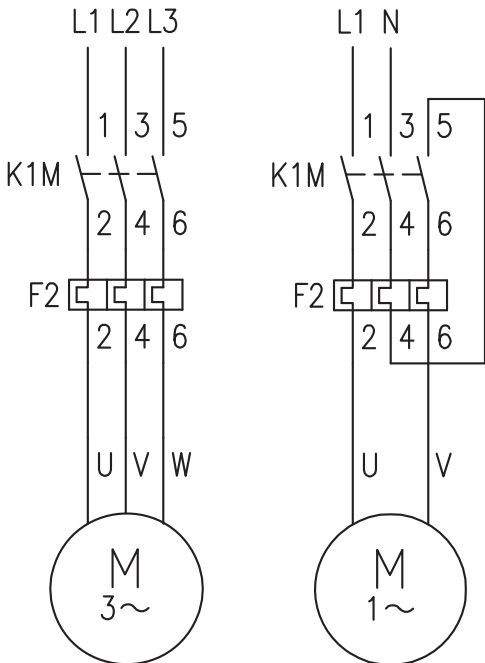

Trip Characteristics

These trip characteristics refer to IEC 60947 and are average values from cold start at an ambient temperature of 20 °C. Trip time is pictured as a function of operating current. With the device at normal operating temperature, the trip time decreases to approximately 25% of the shown value.

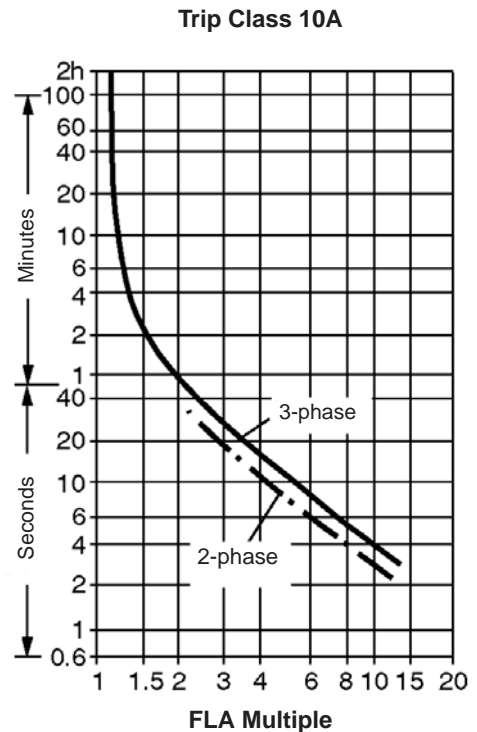

Dimensions are shown in millimeters (inches). Dimensions are not intended for manufacturing purposes.

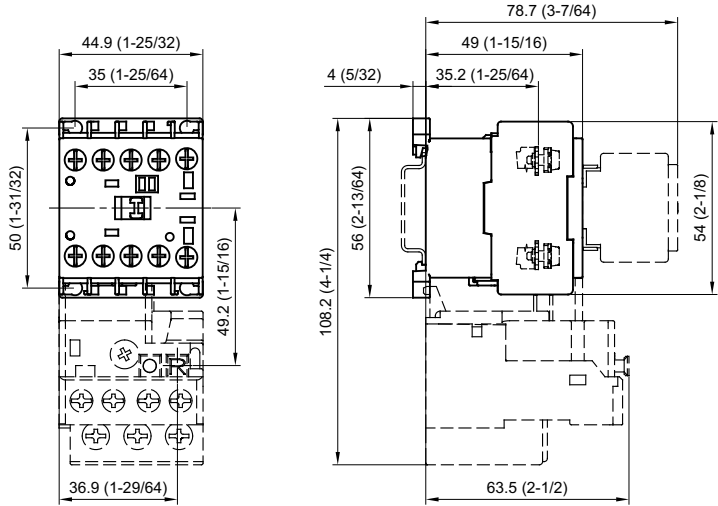

Thermal Overload Relays







Main Circuits

Cat. No.		193-T1...	
Rated isolation voltage U_i		690V AC	
Rated impulse withstand voltage U_{imp} (between main poles and between main poles and auxiliary circuits)		6kV AC	
Rated impulse withstand voltage U_{imp} (between auxiliary circuits)		4kV AC	
Rated operating voltage U_e	IEC	690V AC	440V DC
	UL, CSA	600V AC	
Rated frequencies		[Hz]	50/60
Operational frequencies			DC...400 Hz
Power dissipation	193-T1A, 193-T1B	up to 0.4 A	7 W
		0.5...36 A	6 W
		38 A	12 W
	193-T1C	25...47 A	12 W
	193-T1D	47...90 A	18 W

Control Circuits

Cat. No.			193-T1...	
Rated operating current I_e				
AC-15	24V	[A]	4	
	240V	[A]	2	
	400V	[A]	1.6	
	690V	[A]	0.15	
DC-13	24V	[A]	2	
	110V	[A]	0.4	
	220V	[A]	0.25	
	440V	[A]	0.08	
Thermal Current I_{th}			5	
Short-circuit withstand, Fuse		IEC, gL/gG	[A]	6
Short-circuit withstand, circuit breaker ≤ 1 kA prospective short-circuit-current			[A]	4
Min. contact load for reliable operation			15V, 2 mA	
UL Rating			A600/Q300	

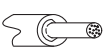
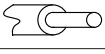
Terminations

Cat. Nos.	Main Circuits						Control Circuits	Remote Reset	
	193-T1A...	193-T1BC20... T1BC25	193-T1BC30... T1BC38	193-T1C...	193-T1D...	193-T1APM	193-T1... all	193-T1R...	
Wiring cross section Terminal type									
Terminal screws	M4	M4	M4	M5	M6	M4	M3.5	M3.5	
 Fine stranded with ferrule	1 conductor [mm ²] 2 conductors [mm ²]	1.5...4 1.5...4	1.5...4 1.5...4	2.5...10 -	2.5...16 -	10...35 -	1.5...10 -	1...2.5 -	
 Solid or coarse stranded	1 conductor [mm ²] 2 conductors [mm ²]	1.5...6 1.5...6	1.5...6 1.5...6	2.5...16 -	2.5...25 -	10...35 -	1.5...16 -	1...2.5 -	
 Solid or coarse stranded	1 conductor [AWG] 2 conductors [AWG]	No. 16...10 No. 16...10	No. 14...10 No. 14...10	No. 10...6 -	No. 10...6 -	No. 8...1 -	No. 16...6 -	No. 18...12 No. 18...12	
Recommended torque	[N•m]	1.5 ... 2.2	1.5 ... 2.2	2.5 ... 3.5	2.5 ... 3.5	4.5 ... 6	1.8...2.8	1.2	1.2
	[lb•in]	13 ... 20	13 ... 20	22 ... 31	22 ... 31	40 ... 53	16...25	10.6	10.6
Pozidrive screwdriver No.	Size	2	2	2	2	-	2	2	2
Slotted screwdriver	[mm]	0.8 x 5.5	0.8 x 5.5	0.8 x 5.5	0.8 x 5.5	-	0.8 x 5.5	0.8 x 5.5	0.8 x 5.5
Hexagon socket screw	Size	-	-	-	-	4	-	-	-

193-T1R Remote Reset

Operating Limits		
Maximum Command Impulse		5s
AC 50/60 Hz	Pick-up [$x U_s$]	0.8...1.1
	Drop-out [$x U_s$]	
DC	Pick-up [$x U_s$]	0.7...1.25
	Drop-out [$x U_s$]	
Coil Consumption		
AC 50/60 Hz	Pick-up [VA/W]	
	Hold-in [VA/W]	
DC	Pick-up [W]	17 (24, 110, 125V) 25 (48V)
	Hold-in [W]	17 (24, 110, 125V) 25 (48V)

General

Cat. No.		193-T1...	
Type of Overload Relay	Bimetallic, Ambient Compensated, Phase Loss Sensitive		
Trip Rating (ultimate tripping current)	120% FLA		
Phase loss sensitivity: Trip rating at phase loss	115% FLA		
Trip Class	193-T1A/-T1B	193-T1C/-T1D	
	IEC/EN 60947-4-1	10A	10
	UL	10	
Reset Mode	Automatic or Manual		
Test release	Manual release of auxiliary contacts		
Trip indication	By means of a flag visible through an opening in the relay front		
Compensation temperature range	-20...+60 °C (-4...+140 °F)		
Climatic Conditions	Release Tolerance at -20 °C	1.05...1.4 $x I_n$	
	Storage Temperature Range	-55...+80 °C (-67...+176 °F)	
	Operating Temperature Range	-20...+60 °C (-4...+140 °F)	
	Air moisture (Storage/Operating) (per IEC/EN 60068-2-6), service	5...95% rel.humidity, non-condensing	
Vibration	IEC/EN 61373 (vibration railways)	category 1, class B	
	IEC/EN 60092-504 (vibration ships), service (per IEC/EN 68000-2-27), transport	0.7 g, all axes, 2...200 Hz	
Shock	(per IEC/EN 68000-2-27), transport	30 g	
	IEC/EN 60068-2-27 (Shock half-sinus), service	11 ms > 5 g all axes	
	IEC/EN 61373 (shock railways)	category 1, class B, 5g 30 ms	
Max. Altitude	2000 m		
Pollution Degree	3		
Degree of Protection, with wires connected	IP2X		
Approximate Weight (unpacked)	193-T1A, 193-T1B	0.16...25 A	0.115 kg
	193-T1B	30...38 A	0.155 kg
	193-T1C	25...47 A	0.330 kg
	193-T1D	47...90 A	0.360 kg
	193-T1...P	47...90 A	0.415 kg
Standards	IEC/EN 60497-1, -4-1, -5-1, UL508, CSA C22.2 No.14		
Certifications	CE, cULus		

Circuit Diagrams

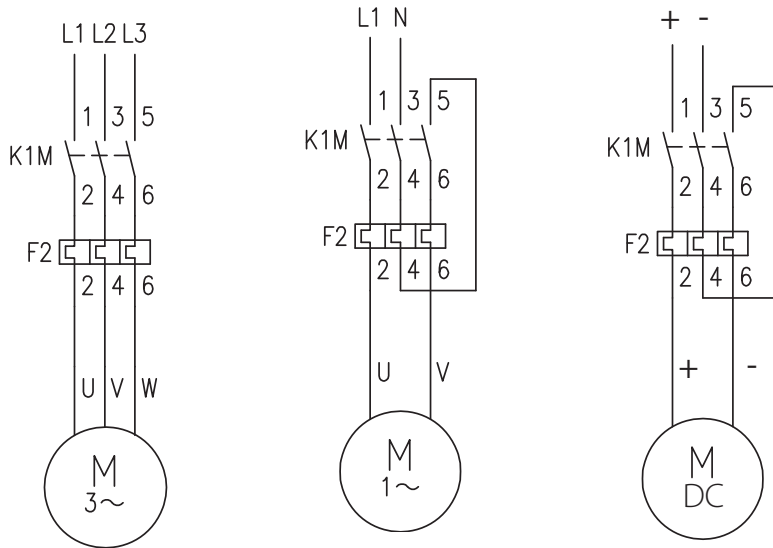

Wiring Schematic

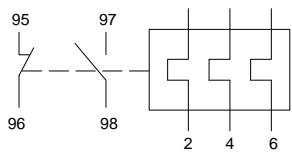

Typical IEC Wiring Schematic

Trip Characteristics

These trip characteristics refer to IEC/EN 60947-4-1 and are average values from cold start at an ambient temperature of 20 °C. Trip time is pictured as a function of operating current. With the device at max. operating temperature, the trip time decreases to approximately 25% of the shown value.

- (a) Tripping characteristics 3-poles from the cold state
- (b) Tripping characteristics 2-poles from the cold state

Cat. Nos. 193-T1AA16...AA40 Overload Relays

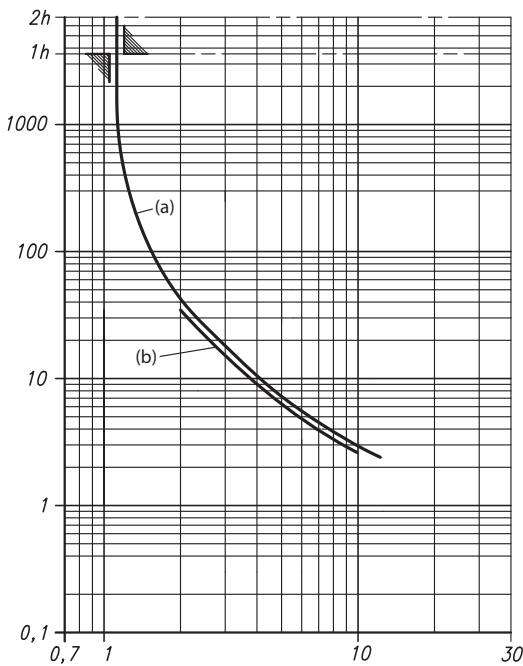

Cat. Nos. 193-T1AA50...AB40 Overload Relays

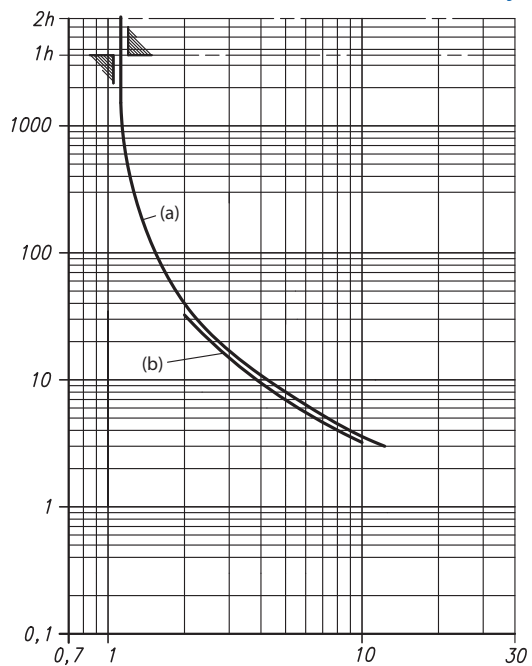

Cat. Nos. 193-T1AB48...AC25 Overload Relays

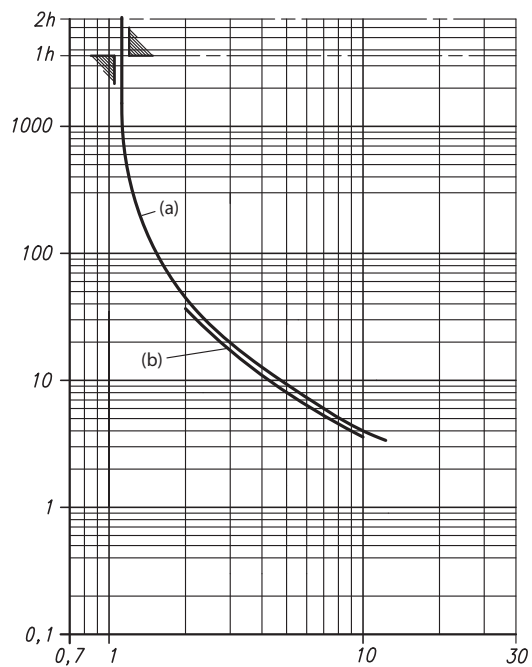

Tripping Time [s]
Multiple of the set current [I_n]

Cat. Nos. 193-T1BC20...BC25 Overload Relays

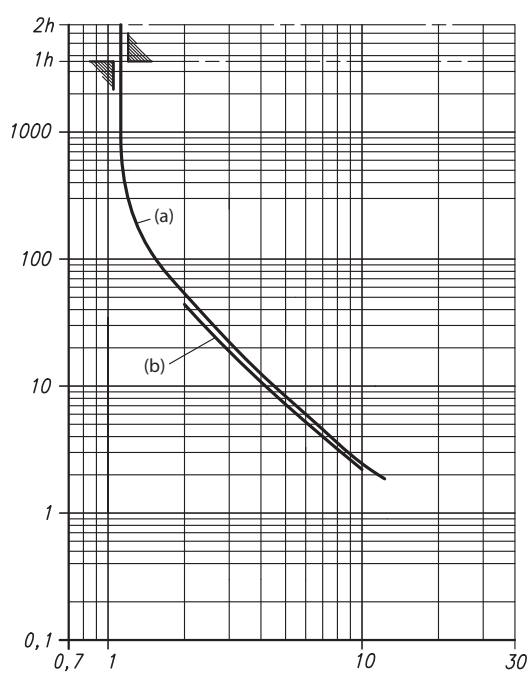

Cat. Nos. 193-T1BC30...BC38 Overload Relays

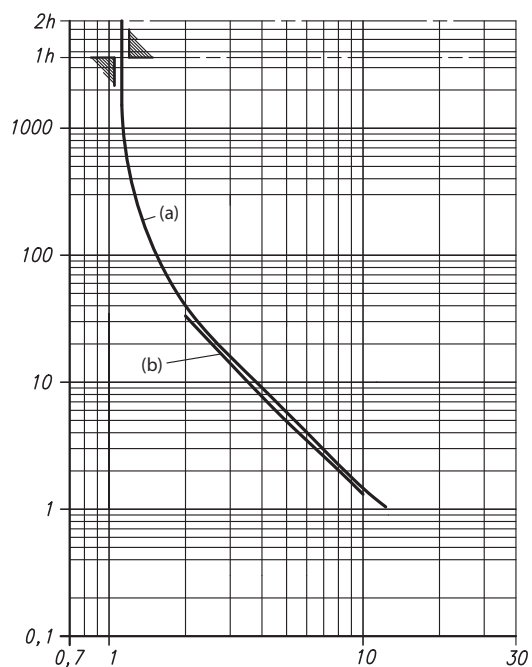

Cat. Nos. 193-T1CC25...CC47 Overload Relays

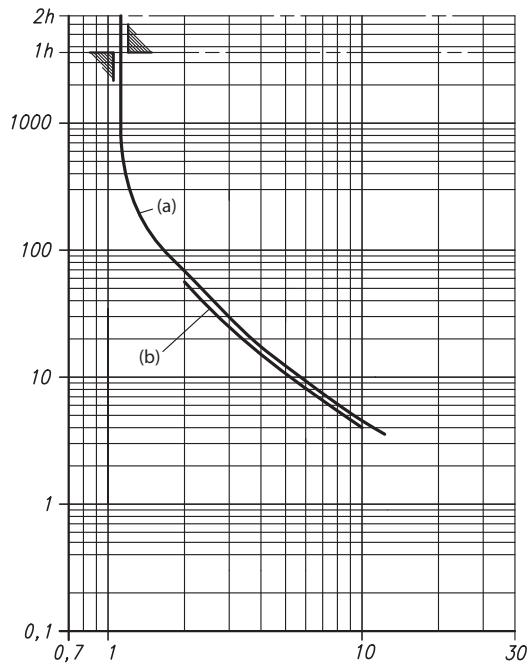

Cat. Nos. 193-T1DC47...DC90 Overload Relays

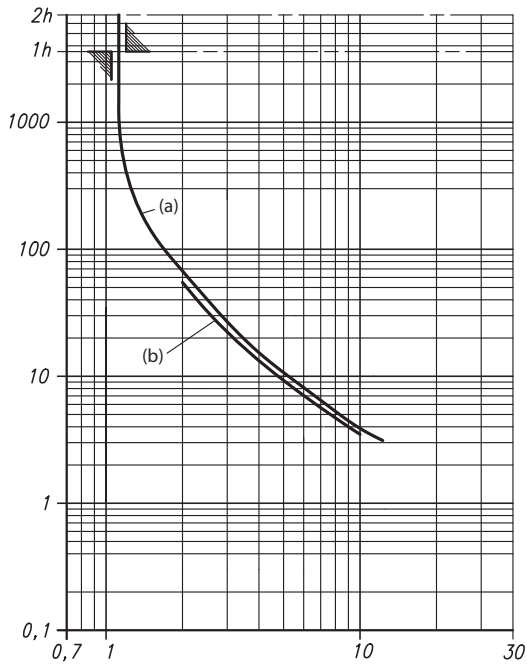

Dimensions are shown in millimeters (inches). Dimensions are not intended for manufacturing purposes.

Cat. Nos. 193-T1AA16...AC25 Overload Relays

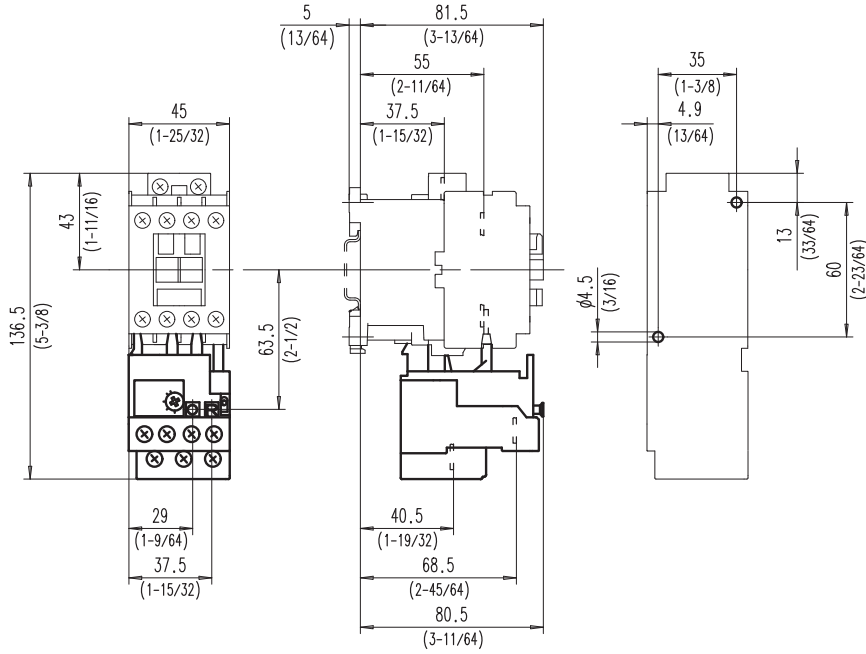

Cat. Nos. 193-T1BC20...25 Overload Relays

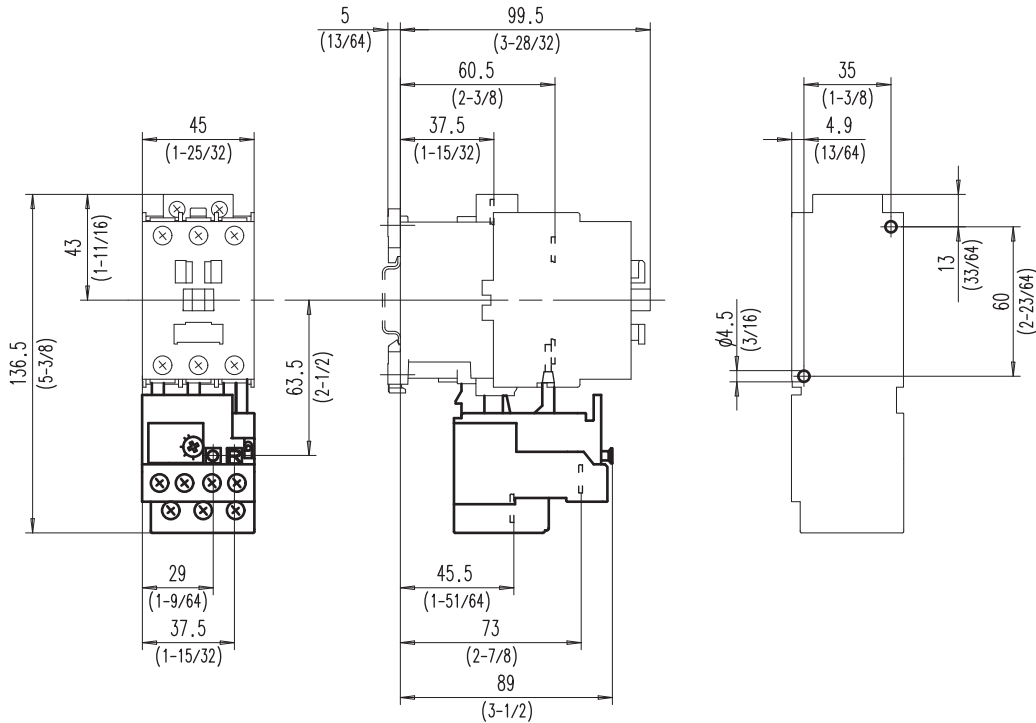

Cat. Nos. 193-T1BC30...38 Overload Relays

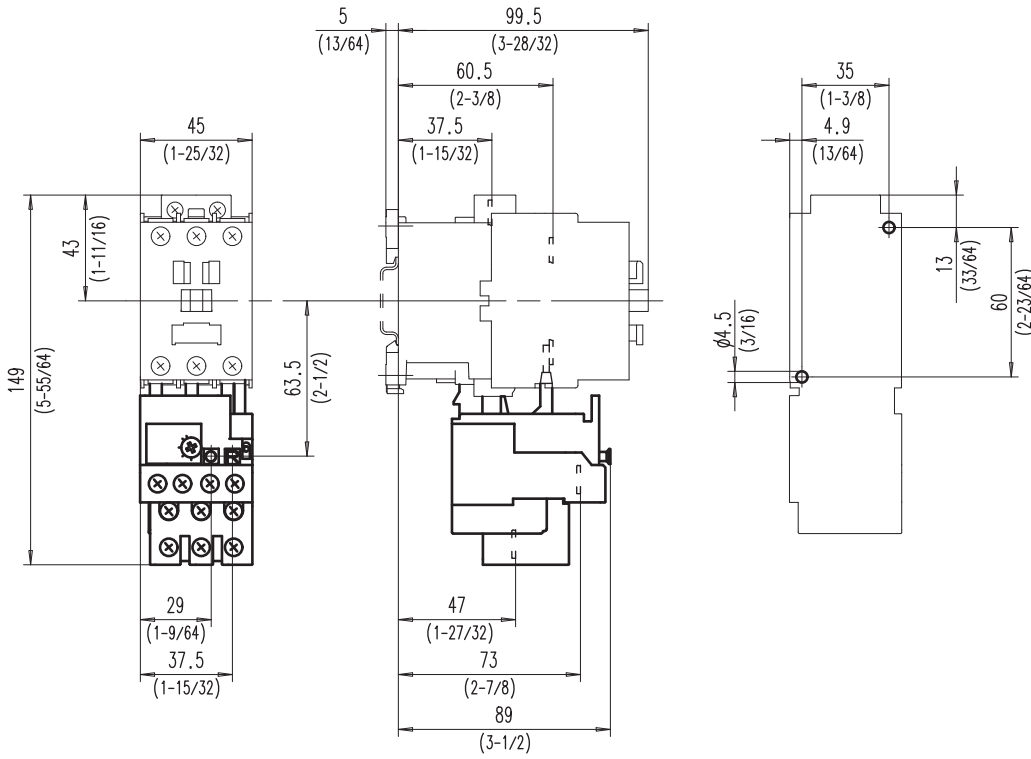

Cat. Nos. 193-T1CC25...47 Overload Relays

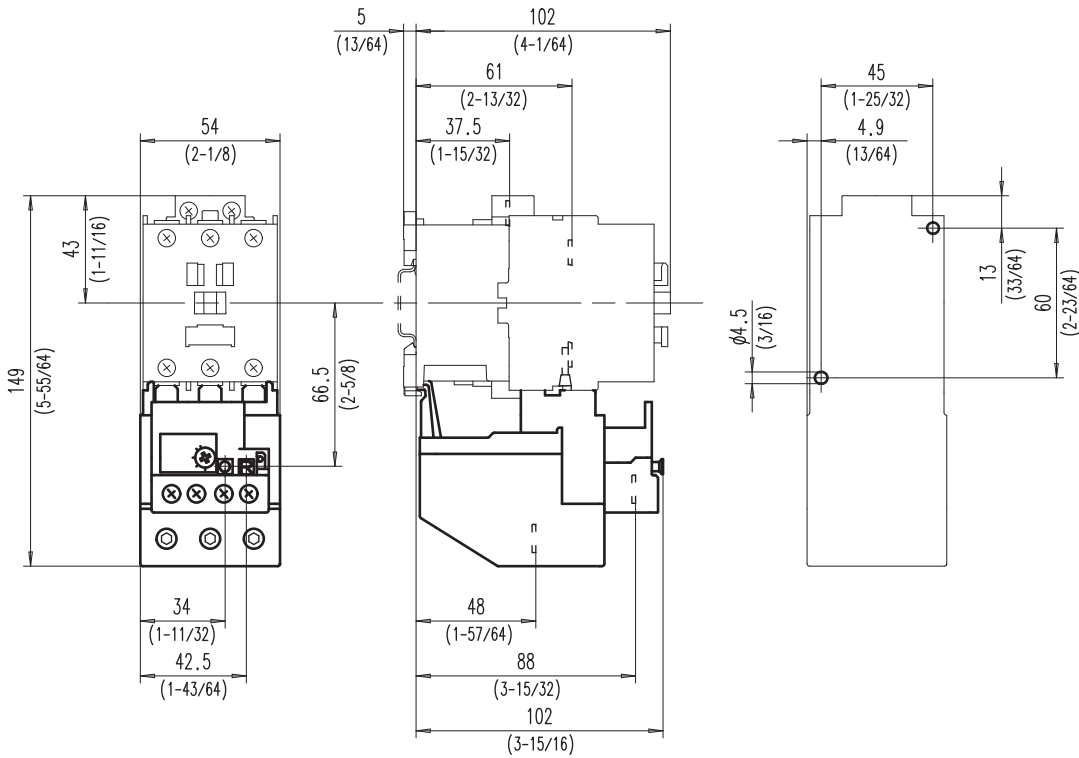

Cat. Nos. 193-T1DC47...90 Overload Relays

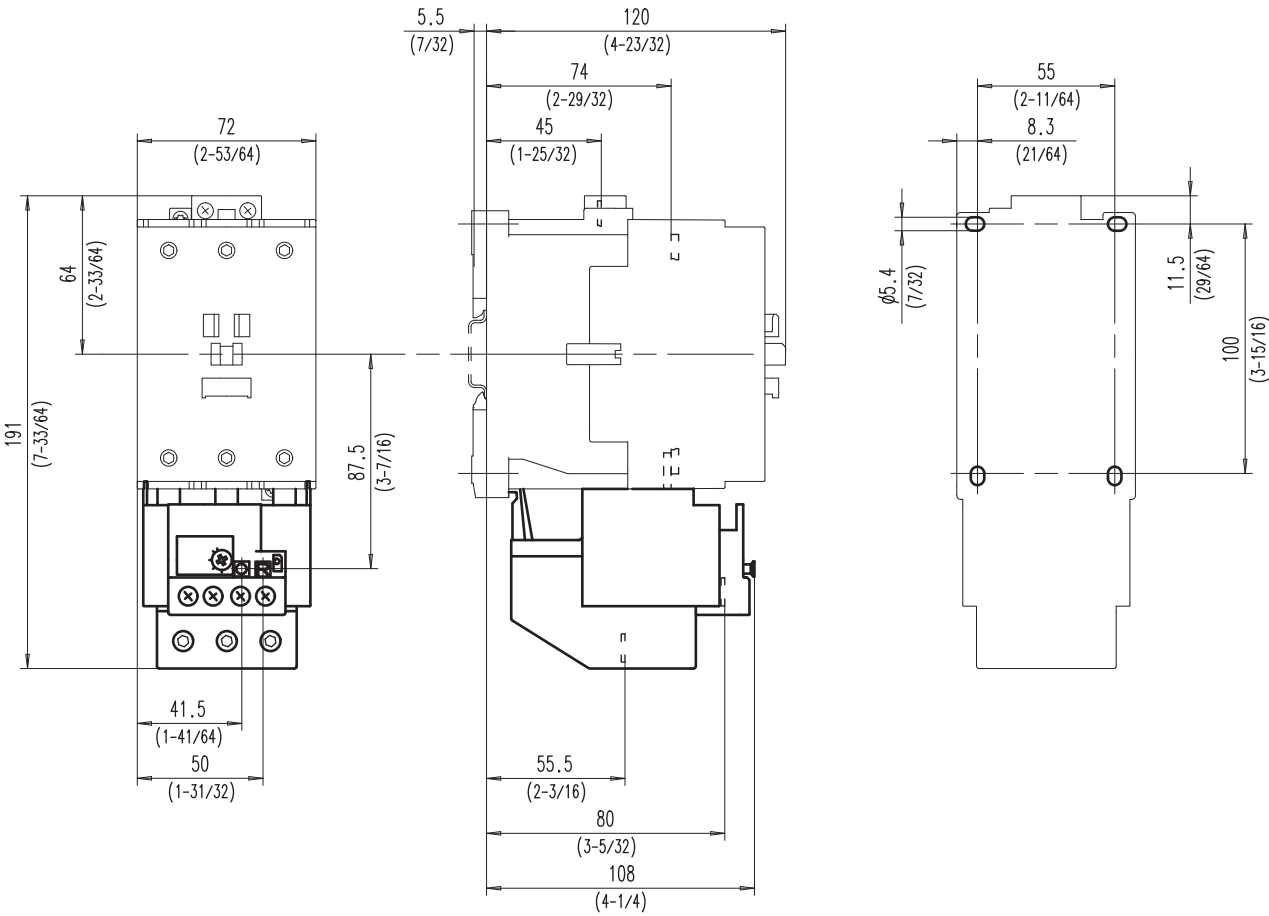

Cat. Nos. 193-T1DC47P...90P Overload Relays

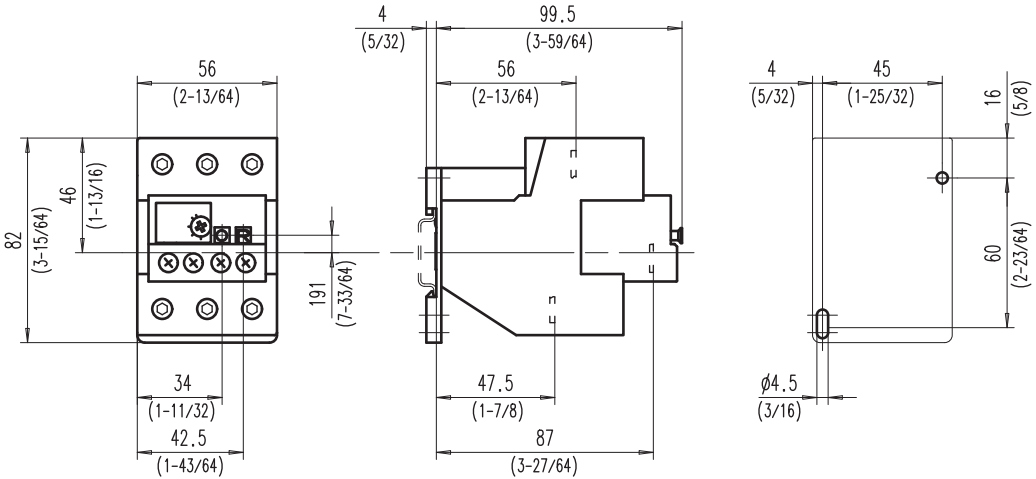

Cat. No. 193-T1APM DIN Rail/Panel Mounting Adapter
 (for use with Cat. Nos. 193-T1AA16...AC25 and 193-T1BC20...25 Overload Relays)

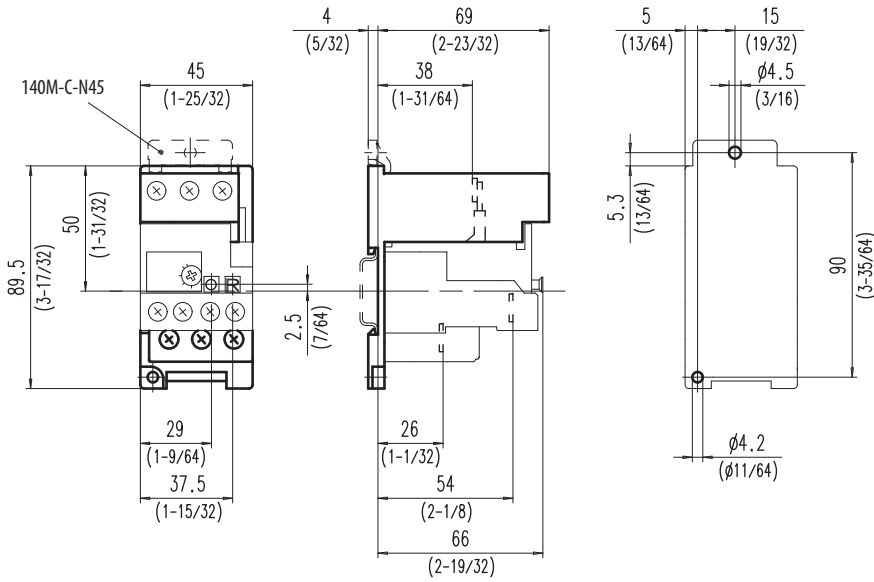

Cat. No. 193-T1APM DIN Rail/Panel Mounting Adapter
 (for use with Cat. No. 193-T1BC30...38 Overload Relays)

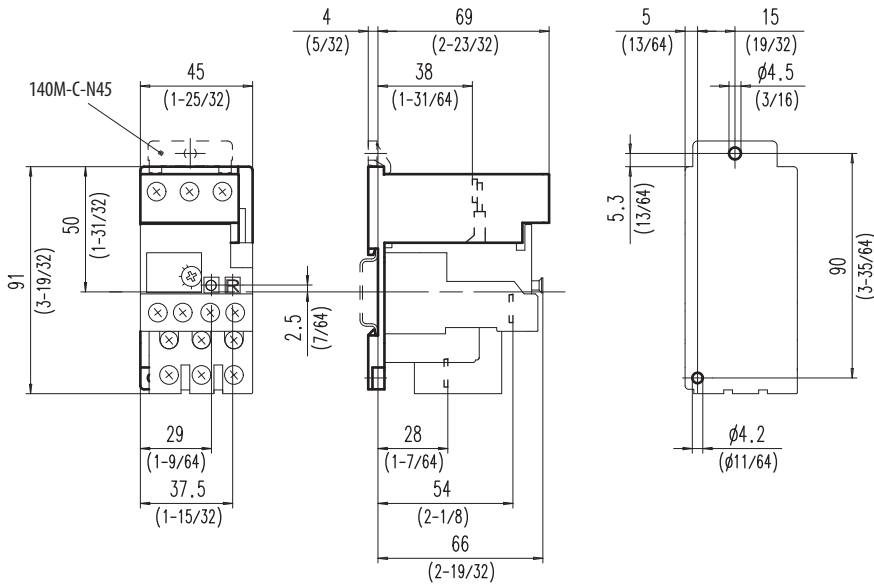

Cat. No. 193-RA3 Reset Adapter

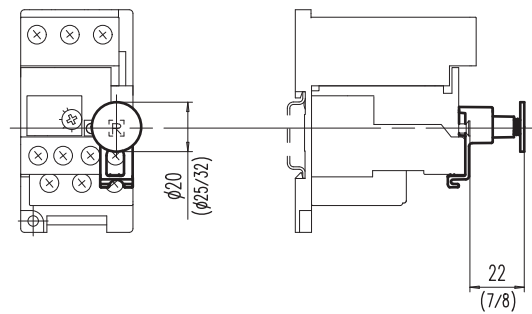

Cat. No. 193-T1R Remote Reset Solenoid

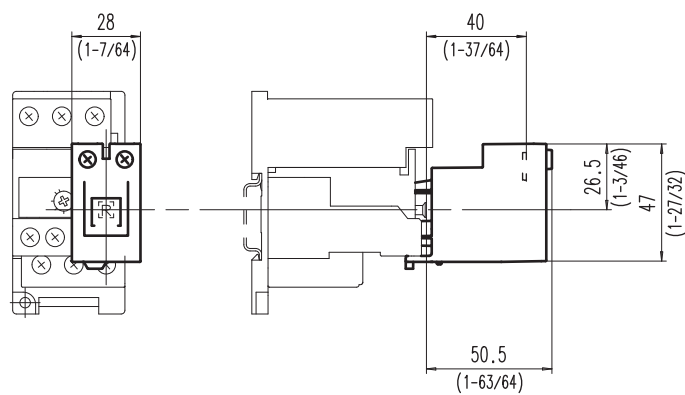

Important User Information

Read this document and the documents listed in the additional resources section about installation, configuration, and operation of this equipment before you install, configure, operate, or maintain this product. Users are required to familiarize themselves with installation and wiring instructions in addition to requirements of all applicable codes, laws, and standards.

Activities including installation, adjustments, putting into service, use, assembly, disassembly, and maintenance are required to be carried out by suitably trained personnel in accordance with applicable code of practice.

If this equipment is used in a manner not specified by the manufacturer, the protection provided by the equipment may be impaired.

In no event will Rockwell Automation, Inc. be responsible or liable for indirect or consequential damages resulting from the use or application of this equipment.

The examples and diagrams in this manual are included solely for illustrative purposes. Because of the many variables and requirements associated with any particular installation, Rockwell Automation, Inc. cannot assume responsibility or liability for actual use based on the examples and diagrams.

No patent liability is assumed by Rockwell Automation, Inc. with respect to use of information, circuits, equipment, or software described in this manual.

Reproduction of the contents of this manual, in whole or in part, without written permission of Rockwell Automation, Inc., is prohibited.

Documentation Feedback

Your comments will help us serve your documentation needs better. If you have any suggestions on how to improve this document, complete this form, publication [RA-DU002](#), available at <http://www.rockwellautomation.com/literature/>.

Allen-Bradley, Rockwell Software, Rockwell Automation, and LISTEN. THINK. SOLVE are trademarks of Rockwell Automation, Inc.
Trademarks not belonging to Rockwell Automation are property of their respective companies.

Rockwell Otomasyon Ticaret A.Ş., Kar Plaza İş Merkezi E Blok Kat:6 34752 İçerenköy, İstanbul, Tel: +90 (216) 5698400

www.rockwellautomation.com

Power, Control and Information Solutions Headquarters

Americas: Rockwell Automation, 1201 South Second Street, Milwaukee, WI 53204-2496 USA, Tel: (1) 414.382.2000, Fax: (1) 414.382.4444
Europe/Middle East/Africa: Rockwell Automation NV, Pegasus Park, De Kleetlaan 12a, 1831 Diegem, Belgium, Tel: (32) 2 663 0600, Fax: (32) 2 663 0640
Asia Pacific: Rockwell Automation, Level 14, Core F, Cyberport 3, 100 Cyberport Road, Hong Kong, Tel: (852) 2887 4788, Fax: (852) 2508 1846